

ROTARY SCREW COMPRESSOR  
CSM MINI 3 - 4 - 5,5 - 7,5 - 10 <sup>NEW</sup> HP

TECHNOLOGY YOU CAN TRUST

# The CSM MINI Range

MINI 3 - 4 - 5,5 - 7,5 - 10 HP

A solution to satisfy all needs



## Base Mounted Version

Especially recommended for installations near the place of use or the expansion of existing systems.

The electrocompressor's main components are: air suction filter, compressor, electric motor, oil filter and cooler, air cooling system, electrical panel for power-on and adjustment, support base and elegant sound-proof casing.

## Tank Mounted Version

Particularly recommended for new or stand-alone installations where there is a need for compressed air with a low noise level.

The unit consists of an electrocompressor on a fixed, 200 and 270-litre tank.



## Dry Version

Especially recommended for installations with compressed air demands with a low dew point.

The compression unit is made up of electrocompressor, tank and refrigerating dryer with gas R134a with indicator of the dew point and timed condensate drain.

# Reliability

## Ceccato has been producing compressed air since 1938

It is a compressor constructed with components that have been tested for years in many industrial plants.

- **A high-efficiency screw assembly.**
- **top brand-name components.**
- **high-tech assembling.**
- **industrial compressor know-how.**
- **the CSM MINI compressor's reliability is the result of decades of experience in the production and treatment of compressed air.**

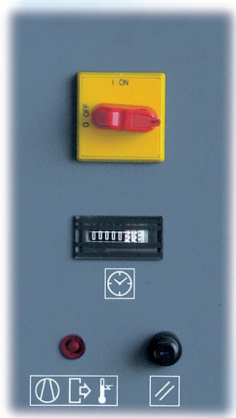

CSM MINI comes standard with a magneto-thermal circuit-breaker main switch that protects both the machine and the power line.

All machine parts are protected against any anomaly and nothing is allowed to irreparably damage any component or the machine.

The strict observance of safety and environmental hygiene regulations during the design phase and the high degree of efficiency of our assembly lines are our guarantee.

## Maxi low noise level

Given the type of user, the noise pollution produced by small-power compressors was never given the proper attention until now but with CSM MINI, the problem has been eliminated.

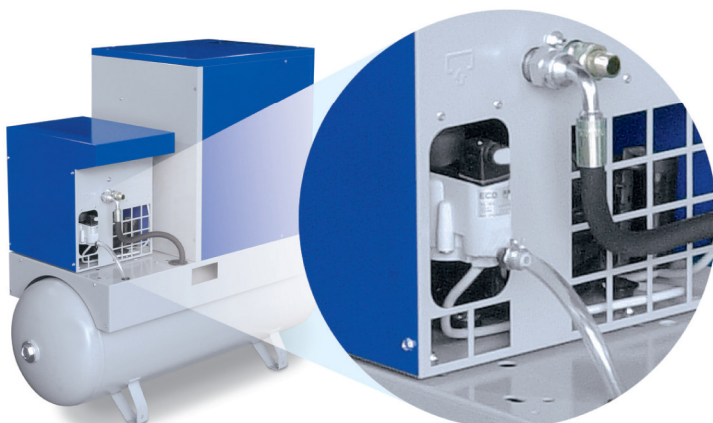
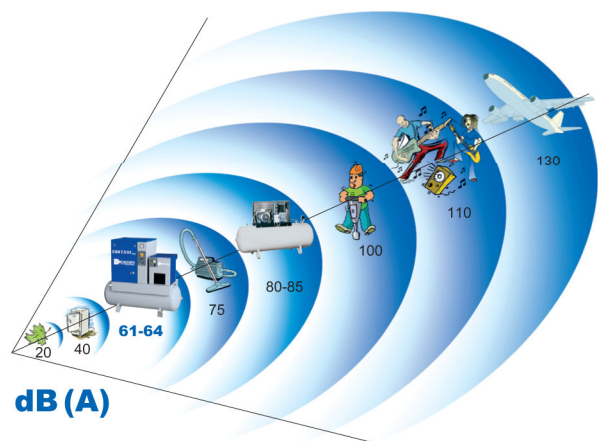

## Smart condensate drain

### Advantages

- **Draining only water and NOT compressed air = Energy savings**
- **Quiet, no acoustic impact = Respect for the environment**

# Technology

## Screw Compressor

A small-power machine with big-compressor components:

- a high-efficiency screw unit for compressing air without metal parts touching;
- an efficient cooling system;
- dry air in the DRY version with dryer;
- completely automatic operation for an industrial service;
- a complete compression unit ready to use.

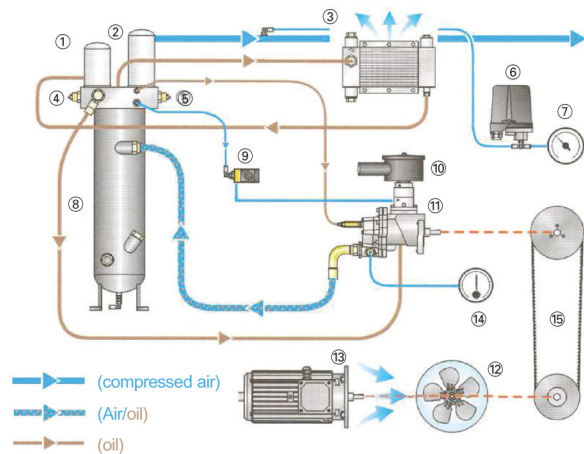
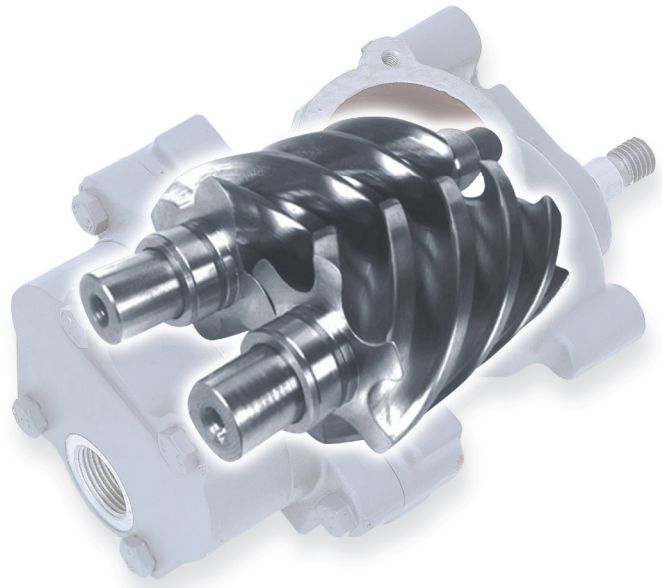

## Adjustment

A new adjustment concept, created by combining the advantages of a piston compressor with those of a screw compressor.

Simple and complete instrumentation for correctly using and operating the compressor.

- |                              |                                |
|------------------------------|--------------------------------|
| 1 - Oil filter               | 9 - Air suction solenoid valve |
| 2 - Air-oil separator filter | 10 - Air suction air filter    |
| 3 - Oil cooler               | 11 - Screw compressor          |
| 4 - Thermostatic valve       | 12 - Fan                       |
| 5 - Safety valve             | 13 - Electric motor            |
| 6 - Pressure switch          | 14 - Thermometer/Thermostat    |
| 7 - Pressure gauge           | 15 - Transmission unit         |
| 8 - Oil reservoir            |                                |

## Dry air

The CSM MINI with CDX dryer is the winning solution for specific uses that require condensate-free air:

- supplies condensed air without condensate;
- safeguards the operation of the equipment;
- improves the quality of the final product;
- requires less space for installation;
- cancels the cost of installing the dryer;
- respects the environment with the use of ecological gas.



# Why choose CSM MINI

## TWO TECHNOLOGIES COMPARED



yesterday's

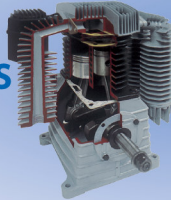

**PISTON COMPRESSORS**



today's



**SCREW COMPRESSORS**

70 - 75% of the intake air

**Air yield**

95% of the intake air  
More air with lower energy costs

Greater than 80 dB(A)

**Sound level**

MINI from 61 to 66 dB(A)  
Almost as low as a household appliance

For intermittent use

**Operation**

Also for continuous use  
An industrial technology

High content of residual  
oil and humidity

**Air quality**

Low oil content and dry air in the  
version with dryer  
Cleaner air for better production

Alternating and pulsing

**Compression**

Continuous and constant  
Uniform pressure in line for better  
functioning utilities

High

**Vibrations**

Absent  
More reliable components

From 7 to 10 times nominal value

**Starting current**

From 3 to 5 times nominal  
value in the star/delta version  
Lower energy consumption at start-up









Thermal circuit breaker

**Standard protections**

Magneto-thermal circuit breaker  
Greater operator safety

Technological evolution, the ever greater needs of increasingly sophisticated users and respect for the environment are just three of the many reasons behind the CSM MINI's design  
the small screw compressor with big compressor performance

TECHNICAL DATA (according to ISO 1217 and CAGI PNEUROP standards)

TYPE															
	bar	psi	hp	kW	l/min	m <sup>3</sup> /h	cfm	dB(A)	V/Hz/Ph	L	W	H	litres	gas	kg
<b>BASE MOUNTED COMPRESSOR</b>															
CSM 3/8 B* MINI	8	118	3	2,2	300	18,0	10,6	61	400/50/3	620	605	950	-	3/4	99
CSM 3/10 B* MINI	10	145	3	2,2	240	14,4	8,5	61	400/50/3	620	605	950	-	3/4	99
CSM 4/8 B MINI	8	118	4	3	445	26,7	15,8	61	400/50/3	620	605	950	-	3/4	103
CSM 4/10 B MINI	10	145	4	3	320	19,2	11,3	61	400/50/3	620	605	950	-	3/4	103
CSM 5,5/8 B MINI	8	118	5,5	4	560	33,6	19,8	62	400/50/3	620	605	950	-	3/4	105
CSM 5,5/10 B MINI	10	145	5,5	4	470	28,2	16,6	62	400/50/3	620	605	950	-	3/4	105
CSM 5,5/8 BX MINI	8	118	5,5	4	560	33,6	19,8	62	400/50/3	620	605	950	-	3/4	105
CSM 5,5/10 BX MINI	10	145	5,5	4	470	28,2	16,6	62	400/50/3	620	605	950	-	3/4	105
CSM 7,5/8 BX MINI	8	118	7,5	5,5	700	42,0	24,8	64	400/50/3	620	605	950	-	3/4	110
CSM 7,5/10 BX MINI	10	145	7,5	5,5	600	36,0	21,2	64	400/50/3	620	605	950	-	3/4	110
CSM 10/8 BX MINI	8	118	10	7,5	1008	60,5	35,7	66	400/50/3	620	635	975	-	3/4	160
CSM 10/10 BX MINI	10	145	10	7,5	920	55,2	32,6	66	400/50/3	620	635	975	-	3/4	160
<b>TANK MOUNTED COMPRESSOR</b>															
CSM 3*8 MINI	8	118	3	2,2	300	18,0	10,6	61	400/50/3	1420	575	1255	200	1/2	155
CSM 3*10 MINI	10	145	3	2,2	240	14,4	8,5	61	400/50/3	1420	575	1255	200	1/2	155
CSM 4/8 MINI	8	118	4	3	445	26,7	15,8	61	400/50/3	1420	575	1255	200	1/2	157
CSM 4/10 MINI	10	145	4	3	320	19,2	11,3	61	400/50/3	1420	575	1255	200	1/2	157
CSM 5,5/8 MINI	8	118	5,5	4	560	33,6	19,8	62	400/50/3	1420	575	1255	200	1/2	159
CSM 5,5/10 MINI	10	145	5,5	4	470	28,2	16,6	62	400/50/3	1420	575	1255	200	1/2	159
CSM 5,5/8 X MINI	8	118	5,5	4	560	33,6	19,8	62	400/50/3	1420	575	1255	200	1/2	159
CSM 5,5/10 X MINI	10	145	5,5	4	470	28,2	16,6	62	400/50/3	1420	575	1255	200	1/2	159
CSM 7,5/8 X MINI	8	118	7,5	5,5	700	42,0	24,8	64	400/50/3	1420	575	1255	200	1/2	164
CSM 7,5/10 X MINI	10	145	7,5	5,5	600	36,0	21,2	64	400/50/3	1420	575	1255	200	1/2	164
CSM 10/8 X MINI	8	118	10	7,5	1008	60,5	35,7	66	400/50/3	1420	648	1280	200	1/2	214
CSM 10/10 X MINI	10	145	10	7,5	920	55,2	32,6	66	400/50/3	1420	648	1280	200	1/2	214
<b>BASE MOUNTED COMPRESSOR</b>															
CSM 3/8 D* MINI	8	118	3	2,2	300	18,0	10,6	61	400/50/3	1420	575	1255	200	1/2	187
CSM 3/10 D* MINI	10	145	3	2,2	240	14,4	8,5	61	400/50/3	1420	575	1255	200	1/2	187
CSM 4/8 D MINI	8	118	4	3	445	26,7	15,8	61	400/50/3	1420	575	1255	200	1/2	191
CSM 4/10 D MINI	10	145	4	3	320	19,2	11,3	61	400/50/3	1420	575	1255	200	1/2	191
CSM 5,5/8 D MINI	8	118	5,5	4	560	33,6	19,8	62	400/50/3	1420	575	1255	200	1/2	193
CSM 5,5/10 D MINI	10	145	5,5	4	470	28,2	16,6	62	400/50/3	1420	575	1255	200	1/2	193
CSM 5,5/8 DX MINI	8	118	5,5	4	560	33,6	19,8	62	400/50/3	1420	575	1255	200	1/2	193
CSM 5,5/10 DX MINI	10	145	5,5	4	470	28,2	16,6	62	400/50/3	1420	575	1255	200	1/2	193
CSM 7,5/8 DX MINI	8	118	7,5	5,5	700	42,0	24,8	64	400/50/3	1420	575	1255	200	1/2	198
CSM 7,5/10 DX MINI	10	145	7,5	5,5	600	36,0	21,2	64	400/50/3	1420	575	1255	200	1/2	198
CSM 10/8 DX MINI	8	118	10	7,5	1008	60,5	35,7	66	400/50/3	1420	648	1280	200	1/2	254
CSM 10/10 DX MINI	10	145	10	7,5	920	55,2	32,6	66	400/50/3	1420	648	1280	200	1/2	249

B = Base mounted      X = Star delta      D = Dry with dryer

new version

Standard Version:

- Direct start-up for 3 and 4 HP - direct or star/delta for 5,5 HP - star/delta for 7,5 and 10 HP.
- Electric motor with IP 55.
- Magneto-thermal mains circuit breaker.
- First oil charge
- \* Also available in 230 Volt/50 Hz, single-phase
- Also available with different voltages
- All versions also available on the 270 liter tank. [ Dimensions (1498x582x1340) (1498x648x1365 only for 10 HP) (Weight: +11 Kg)]



The company reserves the right to make any changes from the point of view of continuous product improvement.



Design, Construction,  
Sales and Service  
for compressors, dryers  
and filters for compressed air

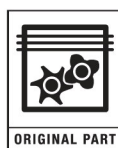

ON SALE AT

6999110010